

10/100 Base-T DIP Transformer

Part Number: 20601D

Page: 1/2

- Compliant with IEEE 802.3 standard.
- RoHS compliant.
- Operating temperature range: 0°C to +70°C.
- Storage temperature range:-20°C to +125°C

Electrical Specifications @ 25°C

Part Number	Turns Ratio (±5%)		OCL(uH Min) @100KHz/0.1V with 8.0mA DC	Insertion Loss (dB Max) 1-100MHz	DCMR (dB Min) 1-100MHz	HI-POT (Vrms)
	TX	RX				
20601D	1CT:1CT	1CT:1CT	350	-1.1	-30	1500

Continue

Part Number	Return Loss (dB Min)					Cross Talk (dB Min)		
	1-30MHz	40MHz	50MHz	60-80MHz	100MHz	30MHz	60MHz	100MHz
20601D	-18	-14.4	-13.1	-12	-10	-40	-35	-30

Schematics:

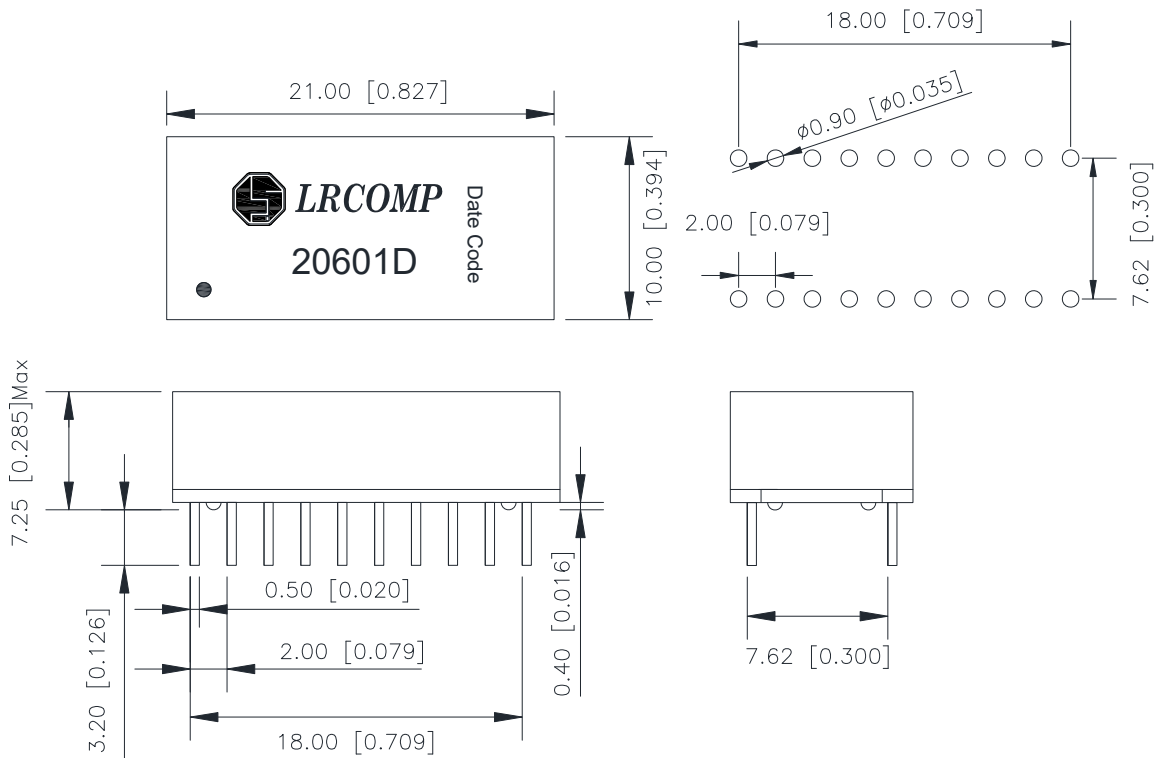

Dimension: mm[Inch]±0.25[0.010]

10/100 Base-T DIP Transformer

Part Number: 20601D

Page: 2/2

Schematics:

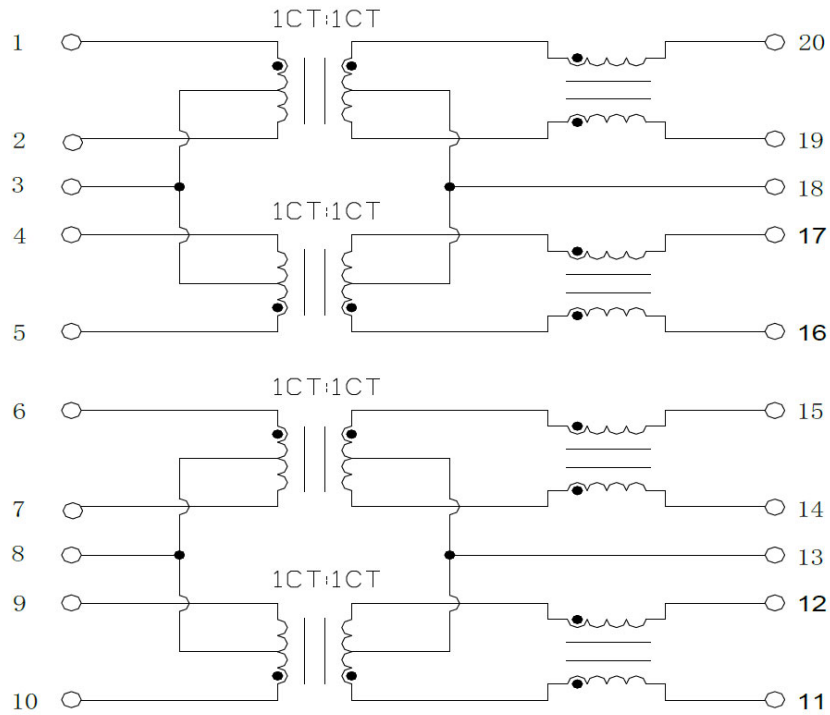

Package:

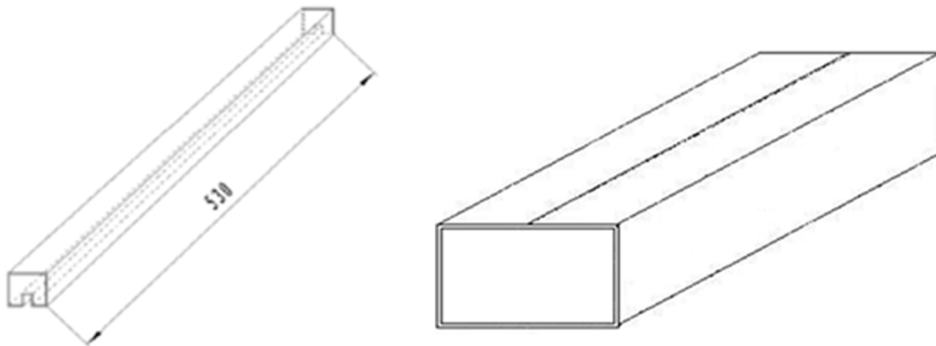

1. Quantity per tube: 24pcs
2. Quantity per carton: 5400pcs