

2.5G SMD Transformer

Part Number: 24131SS

Page: 1/2

- Compliant with IEEE 802.3at standard.
- RoHS compliant.
- Power over Ethernet(PoE) Magnetics,720mA current capability.
- Operating temperature range: 0°C to +70°C.
- Storage temperature range:-20°C to +125°C

Electrical Specifications @ 25°C

Part Number	Turns Ratio (±5%)		OCL(uH Min) @100KHz/0.1V with 8.0mA DC	Insertion Loss (dB Max)	DCMR (dB Min)	HI-POT (Vrms)
	TX	RX		1-125MHz	1-125MHz	
24131SS	1CT:1CT	1CT:1CT	350	-1.0	-28	1500

Continue

Part Number	Return Loss (dB Min)					Cross Talk (dB Min)		
	1-30MHz	50MHz	100MHz	150MHz	200MHz	30MHz	60MHz	125MHz
24131SS	-18	-16	-12	-10	-8	-40	-35	-30

Schematics:

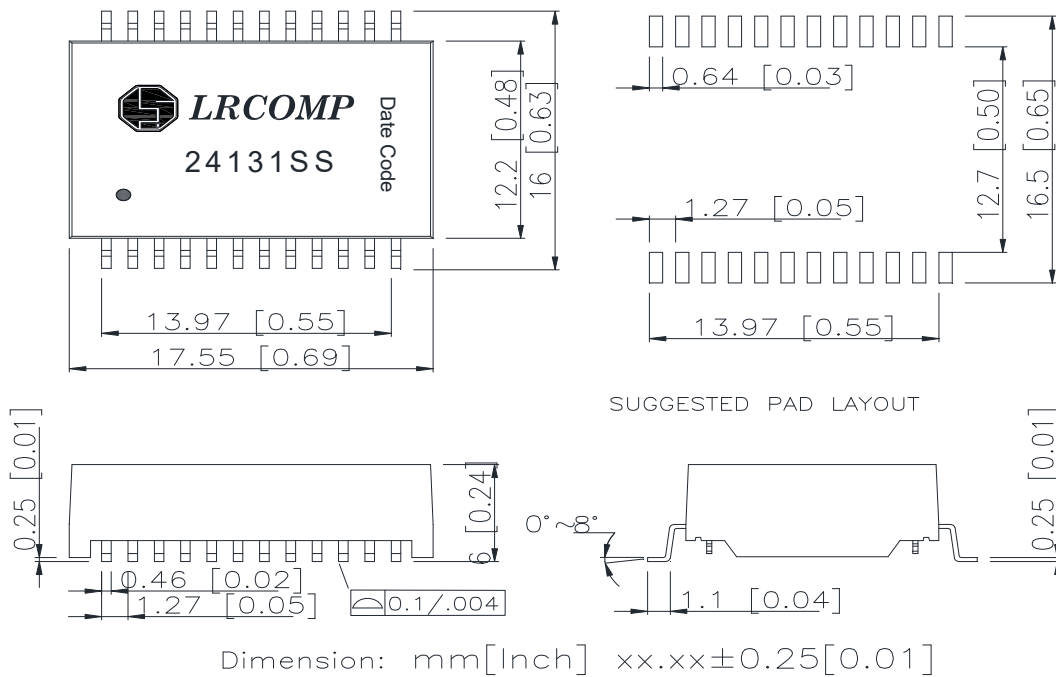

2.5G SMD Transformer

Part Number: 24131SS

Page: 2/2

Schematics:

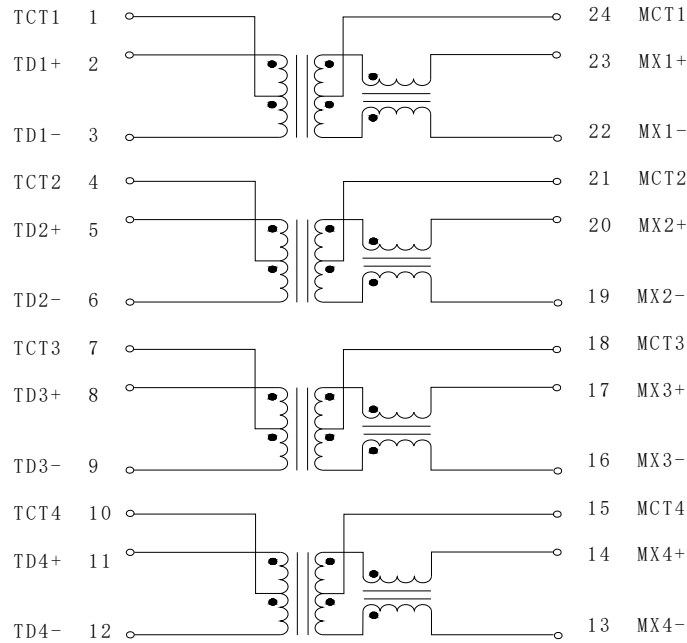

Package:

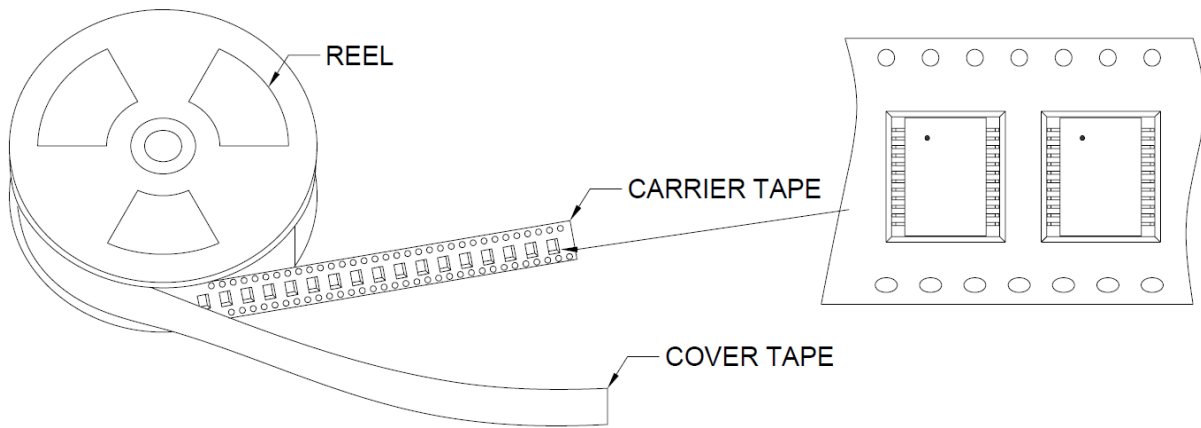

Quantity per reel: 400 pcs

Quantity per big carton: 1600 pcs