

10G SMD Transformer

Part Number: 24695SV

Page: 1/2

- Compliant with IEEE 802.3 standard.
- RoHS compliant.
- Power over Ethernet(PoE) Magnetics, 1.0A current capability.
- Operating temperature range: 0°C to +70°C.
- Storage temperature range: -20°C to +125°C

Electrical Specifications @ 25°C

Part Number	Turns Ratio (±5%)		OCL(uH Min) @100KHz/0.1V	Insertion Loss (dB Max)		HI-POT (Vrms)
	TX	RX		1-400MHz	400-500MHz	
24695SV	1CT:1CT	1CT:1CT	120	-2.0	-3.0	1500

Continue

Part Number	Return Loss (dB Min)		DCMR (dB Min)		Cross Talk (dB Min)	
	1-40MHz	40-500MHz	1-100MHz	100-400MHz	1-100MHz	100-400MHz
24695SV	-18	-18+10*lg(f/40)	-30	-25	-30	-20

Note: f is frequency in MHz.

Schematics:

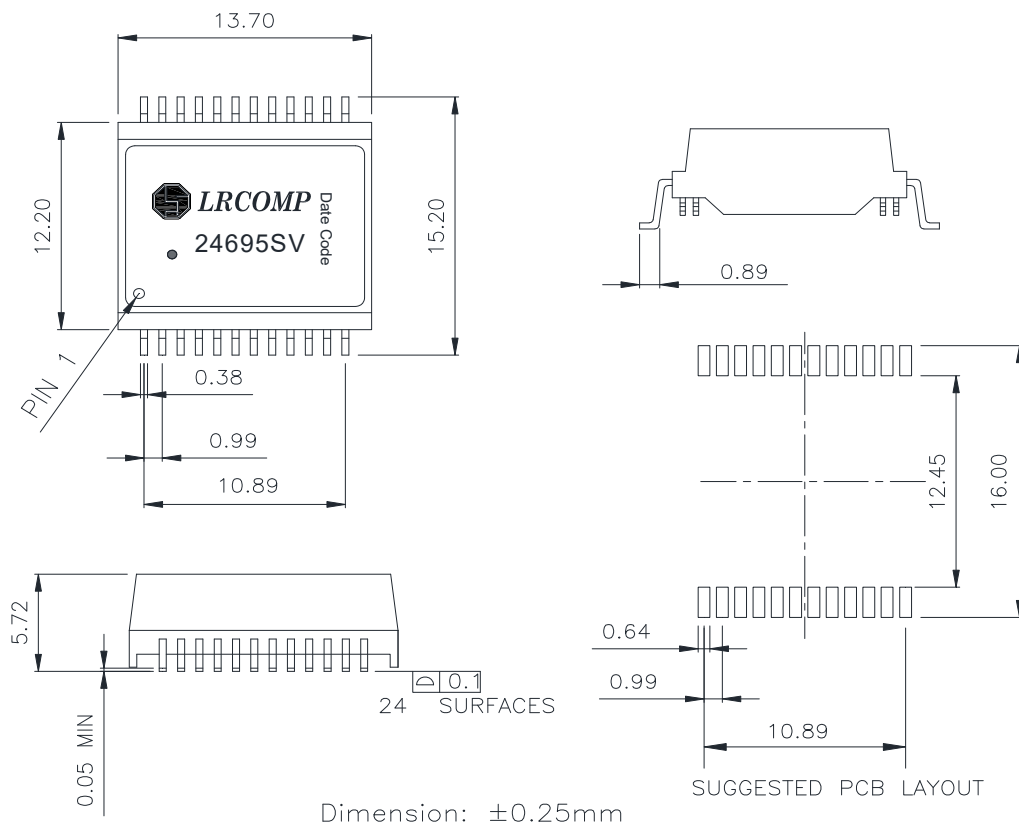

10G SMD Transformer

Part Number: 24695SV

Page: 2/2

Schematics:

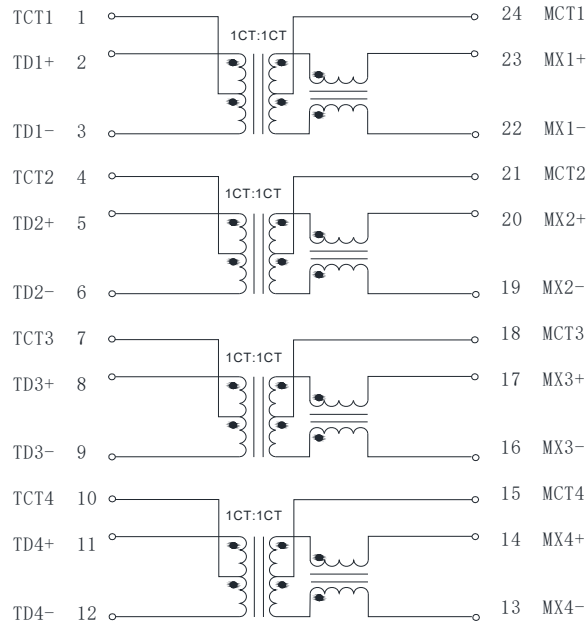

Package:

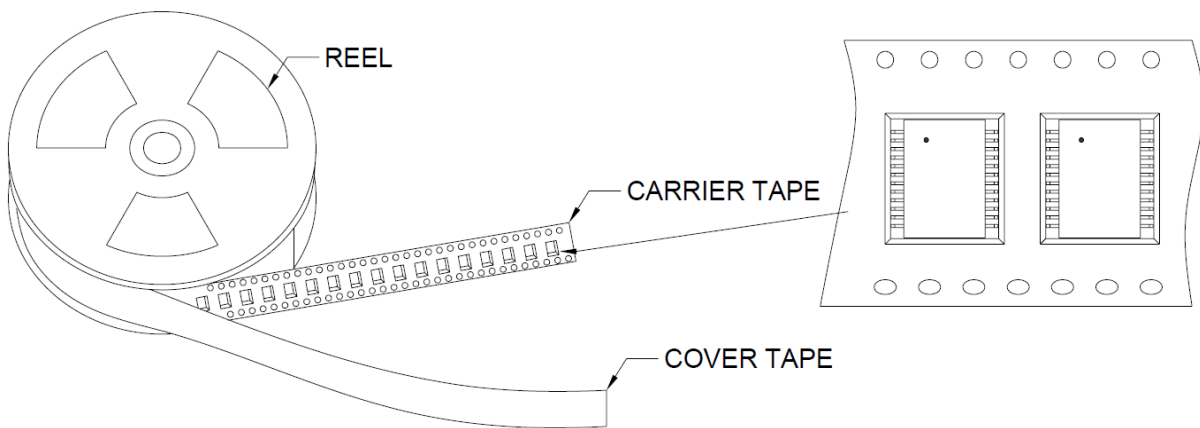

Quantity per reel: 350 pcs

Quantity per big carton: 2100 pcs